

TAN101 v2

PanelPC 10.1" • RK3588 • Android 12

Processeur ROCKCHIP RK3588 (8 Cœurs)

Ecran 10.1" • Résolution 800 x 1280

Dalle P-CAP multipoints

Fanless • IP65 face avant

Wifi AC • Bluetooth 5

1 port RJ45 • 4 USB • 1 RS232

Alimentation 12V~24 DC / 220V AC



front
IP65

Système

Chipset	ROCKCHIP
Processeur	RK3588 8 Coeurs
Proc. Vidéo	Mali G610 MC4
Dalle LCD	10.1" • Résolution 800x1280 • 250 nits
Dalle Tactile	Dalle résistive P-CAP Dalle 10 Points
Mémoire	4GB
Stockage	Emmc 64GB
Entrées / Sorties	1 HDMI 4 USB 3 1 RS232 1 RJ45 1 sortie son
Alimentation	AC 100~240V • DC 12~24V

Communication

Ethernet	1 RJ45
WiFi	WiFi AC
Bluetooth	BT 5
RFID (Option)	125 Khz + 13.56 Mhz

Environnement

Temp. fonctionn.	0°C ~ 50°C
Temp. stockage	-10°C ~ 60°C
Humidité	20% ~ 80°
Certification	FCC / CE

Dimensions / Construction

Matériau	Aluminium / Acier
Dimensions	283 x 186 x 60 mm
Plan découpe	270 x 172 mm
Poids	Environ 2 Kg
Fixation	VESA 75 / 100
Fixation	Panelmount

Accessoires fournis

Alimentation	Alimentation AC / DC 60 Watts
Vis	Kit de vis de fixation VESA
Fixation	Kit de fixation panelmount



Plan

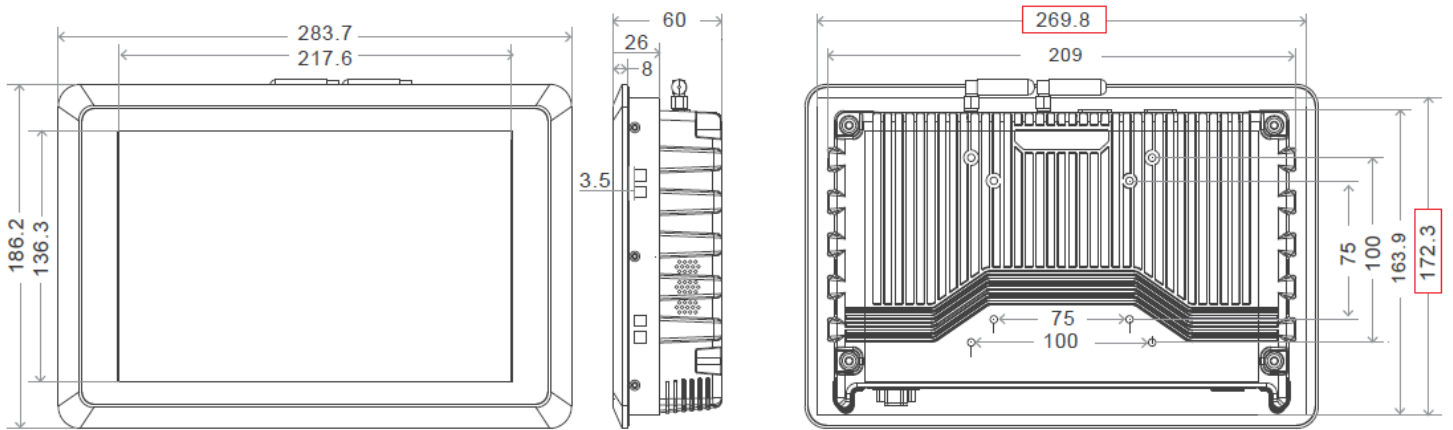

Options



Fixation VESA