









-  Moniteur 17 " • Résolution 1280 x 1024
-  Dalle tactile P-CAP multipoints
-  VGA & DVI
-  Interface USB (RS32 en option)
-  Châssis en métal , face avant IP66
-  Alimentation 12V / 220V AC

**Système**

Taille	17 "
Résolution	1280 x 1024
Luminosité	400 cd
Entrée vidéo	VGA & DVI
Connecteur Tactile	USB
Alimentation	12V DC /220V AC

I/O

Vidéo	VGA & DVI
Tactile	USB
Audio	Non

Mécanique

Construction	Aluminium
Dimensions	386 x 322 x 47 mm
Découpe	376 x 313 mm
Poids	5 Kg

Environnement

Temp. Fonctionne.	0°C ~ + 60°C
Temp. Stockage	-10°C ~ + 70°C
Humidité	10% ~ 90%
Sécurité	FCC, CE

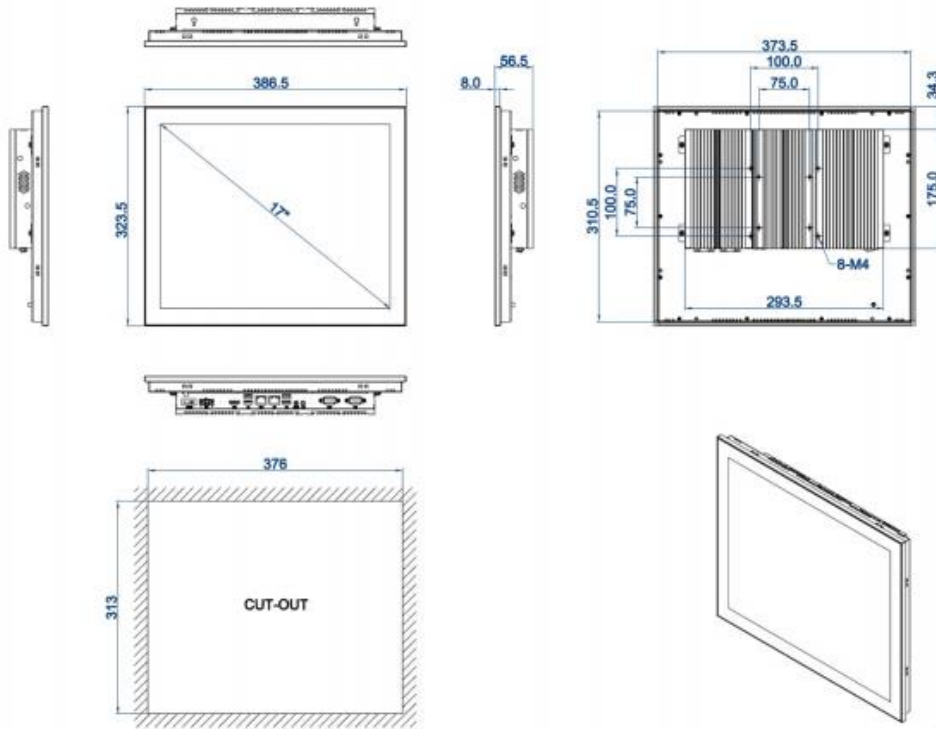

Options

Support fixation	Support VESA 75 & 100
Dalle	Dalle résistive
Alimentation	12V~24V DC

