









-  Moniteur 15" • Résolution 1024 x 768
-  Dalle tactile résistive ( P-CAP en option )
-  Entrée vidéo VGA et DVI
-  Interface tactile USB
-  Châssis en inox IP69K
-  Alimentation intégrée 220V AC



### Système

Taille	15 "
Résolution	1024 x 768
Luminosité	250 cd
Entrée vidéo	VGA & DVI
Connecteur Tactile	USB
Alimentation	Interne 110V/220V AC



### I/O

Vidéo	VGA & DVI
Tactile	USB
Audio	Non

### Mécanique

Construction	Inox
Dimensions	386 x 303 x 90 mm
Poids	7 Kg

**Environnement**

<b>Temp. Fonctionne.</b>	0°C ~ + 60°C
<b>Temp. Stockage</b>	-10°C ~ + 70°C
<b>Humidité</b>	10% ~ 90%
<b>Sécurité</b>	FCC, CE

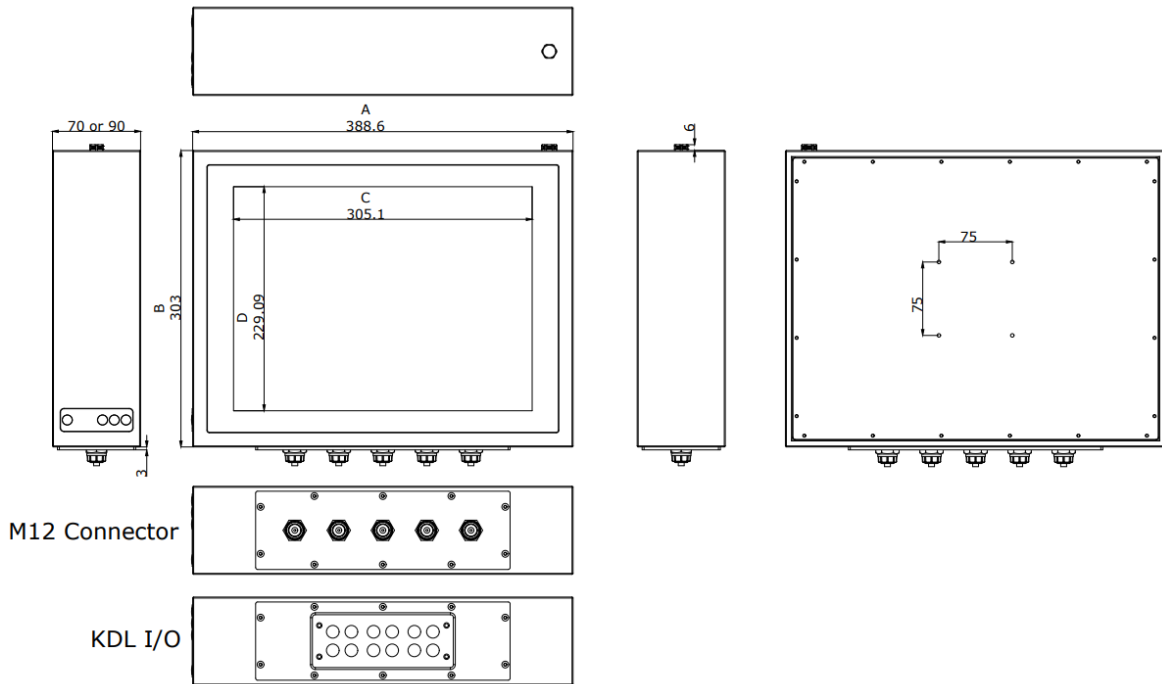

**Options**

<b>Support fixation</b>	Pied / Support VESA 75
<b>Connecteurs IP69</b>	Connecteurs M12 IP69

