











-  Processeur INTEL CORE I3 / I5 / I7
-  Ecran 15" • Résolution 1024 x 768
-  Dalle tactile P-CAP
-  Solution fanless et étanche IP66 face avant
-  Mémoire DDR4 16 max
-  2 ports RS232 • 4 USB
-  2 ports gigabit Ethernet
-  Alimentation externe 12V DC / 220V AC



front  
**IP66**

## Système

<b>Chipset</b>	Intel Skylake
<b>Processeur</b>	Core I3-6100U Core I5-6200U Core I7-6500U
<b>Vidéo</b>	INTEL HD
<b>Mémoire</b>	15" rés. 1024 x 768
<b>Expansion</b>	16GB DDR4 max
<b>Disque dur</b>	2.5" SATA
<b>Port série</b>	6 RS232
<b>Audio</b>	AC97
<b>USB</b>	6 USB
<b>Ethernet</b>	2 Gigabit Ethernet
<b>Alimentation AC/DC</b>	12V~24V DC / 220V AC
<b>TDP</b>	Environ 35 Watts

## I/O

<b>Vidéo</b>	Sortie VGA et HDMI
<b>USB</b>	2 USB 2 / 4 USB 3
<b>RS232</b>	6
<b>RJ45</b>	2
<b>Audio</b>	Oui

## Mécanique

<b>Construction</b>	Acier
<b>Dimensions</b>	352 x 279 x 56 mm
<b>Dim. découpe</b>	341 x 268 mm
<b>Poids</b>	4.5 Kg

**Environnement**

<b>Temp. Fonctionne.</b>	0°C ~ + 50°C
<b>Temp. Stockage</b>	-10°C ~ + 70°C
<b>Humidité</b>	10% ~ 90%
<b>Sécurité</b>	FCC, CE

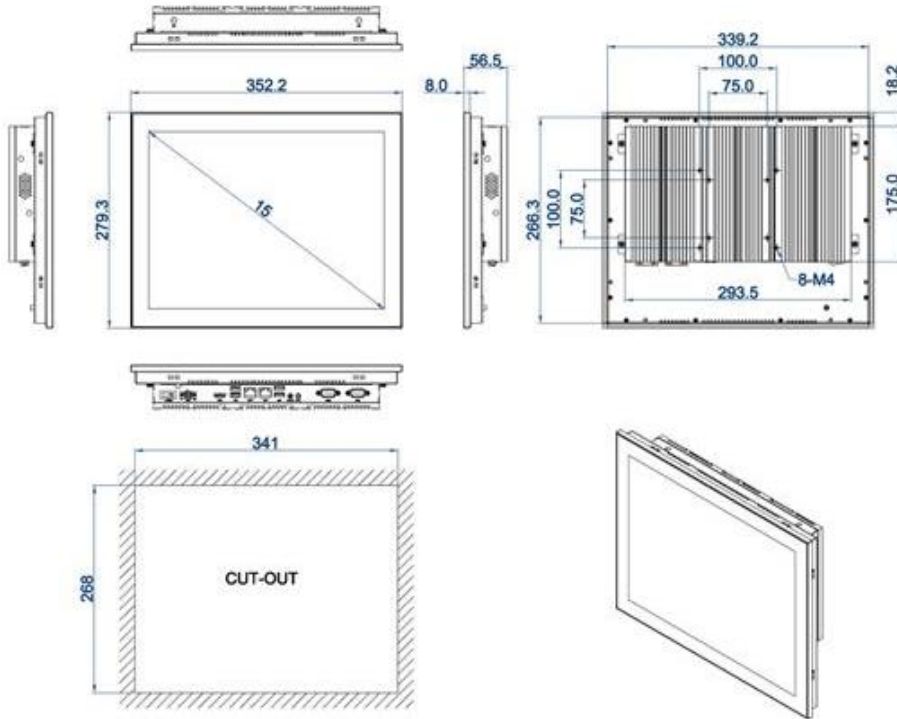

**Options**

<b>Stockage</b>	SSD
<b>Communications</b>	Wifi / Bluetooth
<b>Dalle</b>	Full HD
<b>Support</b>	VESA 75 & 100

