











-  Processeur INTEL Core I3 / Core I5
-  Ecran 21,5" • Résolution 1920 x 1080
-  Dalle tactile résistive ou P-CAP
-  Solution fanless et étanche IP69K
-  Mémoire DDR4 16GB max
-  2 ports RS232 • 4 USB 3.0
-  2 port gigabit Ethernet
-  Alimentation intégrée



Système

Chipset	Intel Kaby Lake
Processeur	Core I3-7100 / I5-7300U
Vidéo	INTEL HD 610/620
Affichage	21,5" rés. 1920 x 1080
Mémoire	16 GB DDR4 max
Disque dur	2.5" SATA
Port série	2 RS232
Audio	AC97
USB	4 USB
Ethernet	2 Gigabit Ethernet
Alimentation AC/DC	220V AC
TDP	Environ 35 Watts

I/O

Vidéo	Sortie HDMI & DP
USB	4
RS232	2
RJ45	2
Audio	Oui

Mécanique

Construction	Inox
Dimensions	533 x 354 x 90 mm
Poids	12 Kg

Environnement

Temp. Fonctionne.	0°C ~ + 50°C
Temp. Stockage	-10°C ~ + 70°C
Humidité	10% ~ 90%
Sécurité	FCC, CE

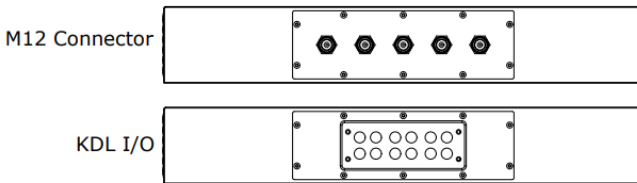
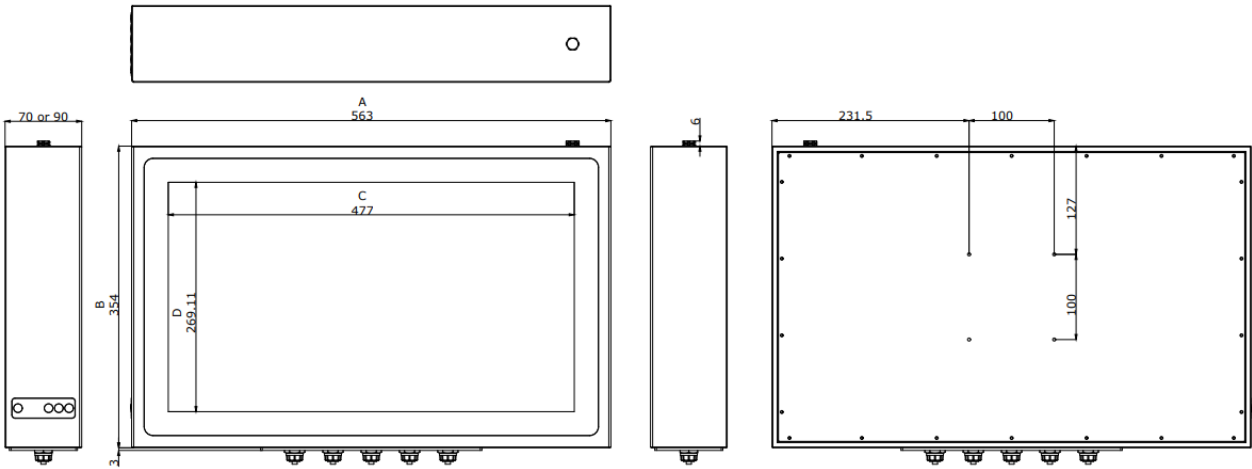

		A	B	C	D	VESA
M185I	TBI/TCI/TXI 185	480.05	305.18	409.96	231.04	750x750
M21I	TBI/TCI/TXI 21	563.00	354.00	477.00	269.11	1000x1000
M24I	TBI/TCI/TXI 24	610.00	382.00	527.04	296.46	1000x1000

Options

Stockage	SSD
Communications	Wifi / Bluetooth
Support	VESA 75
Connectique	M12

