











-  Processeur INTEL Core I5-6300U 3Ghz
-  Ecran 15" 1024 x 768
-  Dalle tactile résistive
-  Solution fanless et étanche en face avant
-  Mémoire DDR4 16G max
-  2 ports RS232 / 4 USB 3.0
-  2 port gigabit Ethernet
-  Alimentation DC 12 / 220 AC



**front  
IP65**

## Système

<b>Chipset</b>	Intel Skylake
<b>Processeur</b>	Intel Core I5-6300U
<b>Vidéo</b>	INTEL HD 520
<b>Mémoire</b>	15" rés. 1024 x 768
<b>Expansion</b>	16 GB max
<b>Disque dur</b>	1 2.5" SATA
<b>Port série</b>	2 RS232
<b>Audio</b>	AC97
<b>USB</b>	4 USB 3.0
<b>Ethernet</b>	2 Gigabit Ethernet
<b>Alimentation AC/DC</b>	12V DC/220VAC
<b>TDP</b>	Environ 35 Watts

## I/O

<b>Vidéo</b>	Sortie DP
<b>USB</b>	3 USB 3.0
<b>RS232</b>	2
<b>RJ45</b>	2
<b>Audio</b>	Oui

## Mécanique

<b>Construction</b>	Acier / Inox
<b>Dimensions</b>	379 x 280 x 79 mm
<b>Poids</b>	7 Kg

Environnement	
Temp. Fonctionne.	0°C ~ + 50°C
Temp. Stockage	-10°C ~ + 70°C
Humidité	10% ~ 90%
Sécurité	FCC, CE

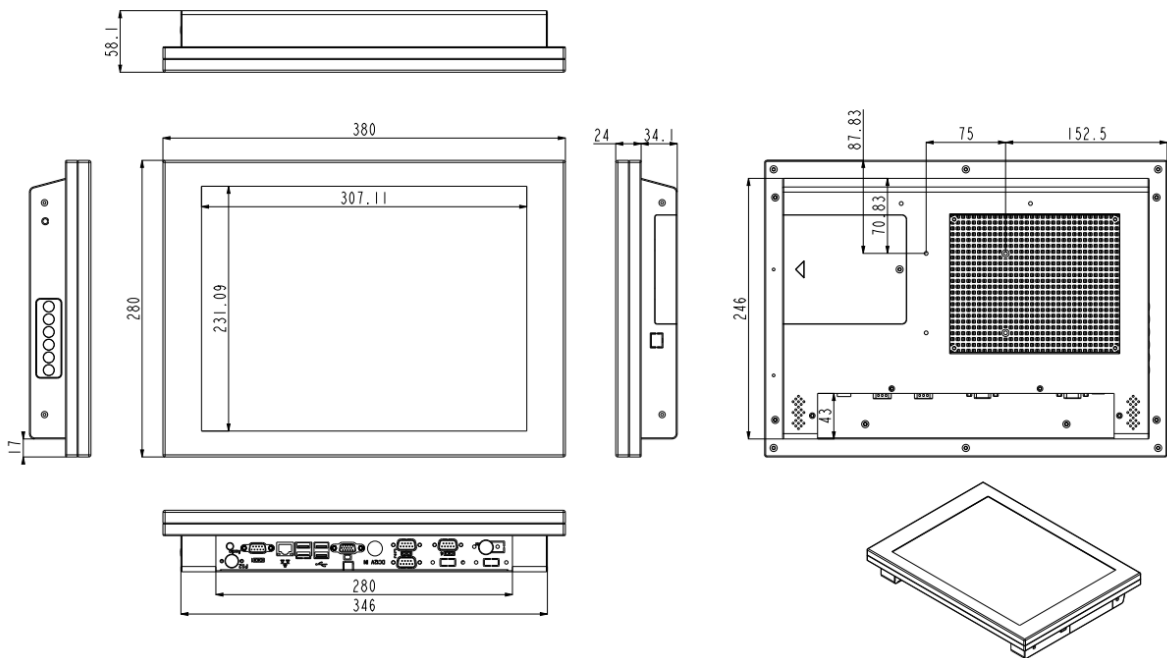
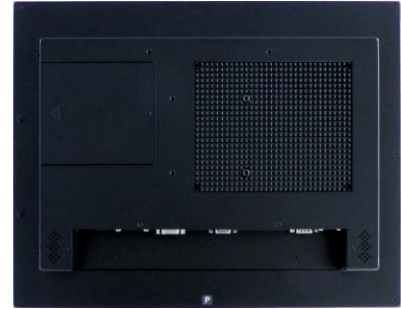

Options	
Stockage	SSD
Communications	Wifi / Bluetooth
Support	VESA 75

