











-  Processeur INTEL Core I5-6300U 3Ghz
-  Ecran 19" 1280 x 1024
-  Dalle tactile résistive
-  Solution fanless et étanche en face avant
-  Mémoire DDR4 16G max
-  2 ports RS232 / 4 USB 3.0
-  2 port gigabit Ethernet
-  Alimentation DC 12 / 220 AC



Système	
Chipset	Intel Skylake
Processeur	Intel Core I5-6300U
Vidéo	INTEL HD 520
Mémoire	19" rés. 1280 x 1024
Expansion	16 GB max
Disque dur	1 2.5" SATA
Port série	2 RS232
Audio	AC97
USB	4 USB 3.0
Ethernet	2 Gigabit Ethernet
Alimentation AC/DC	12V DC/220VAC
TDP	Environ 35 Watts

I/O	
Vidéo	Sortie DP
USB	3 USB 3.0
RS232	2
RJ45	2
Audio	Oui

Mécanique	
Construction	Acier / Inox
Dimensions	466 x 357 x 66 mm
Poids	8 Kg

Environnement

Temp. Fonctionne.	0°C ~ + 50°C
Temp. Stockage	-10°C ~ + 70°C
Humidité	10% ~ 90%
Sécurité	FCC, CE

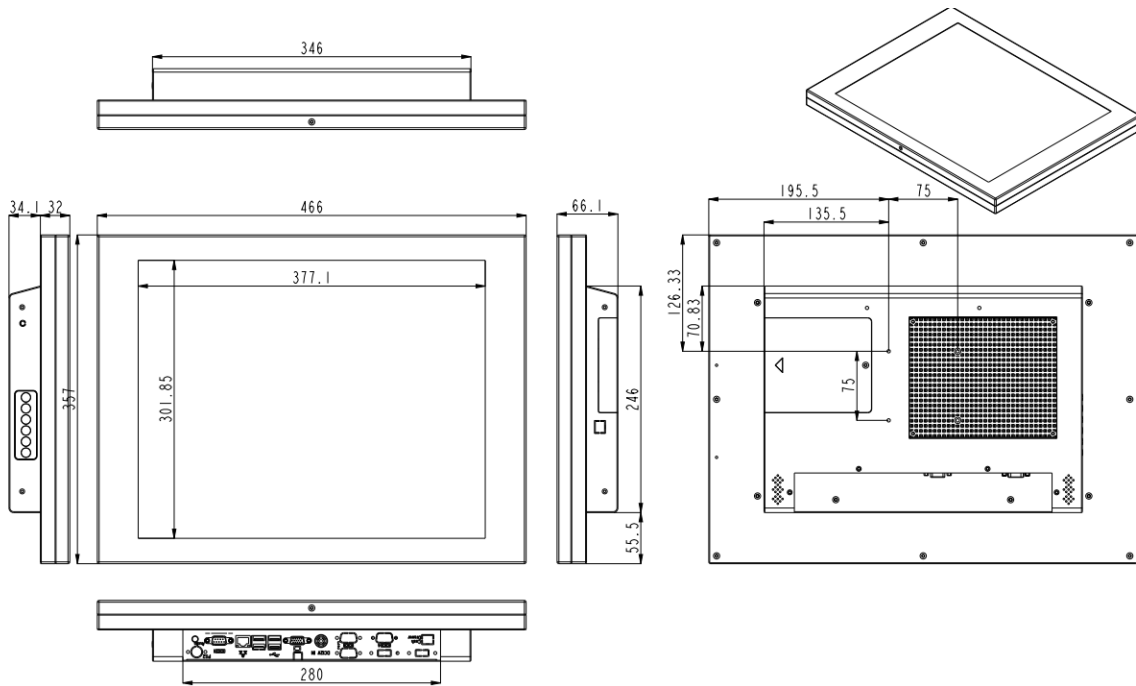
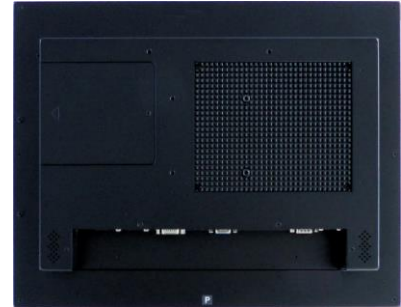

Options

Stockage	SSD
Communications	Wifi / Bluetooth
Support	VESA 75

